

Certified safes
YSM/250/EG1 - Home safe

Specifications:

- 22mm electronically motorised locking bolts
- User code and mastercode function
- 6 lever double bitted manual override lock
- 2 keys supplied
- Laser cut door for minimum gap
- Reinforced hinge and mounted door opening spring
- Armoured steel anti drill plates: Side of safe, top of safe & between door and faceplate
- Volume 18.6 litres

Features:

- Digital keypad with blue backlight LCD display
- Resettable 3 to 8 digit usercode
- Low battery warning
- Display code on/off function
- Internal light

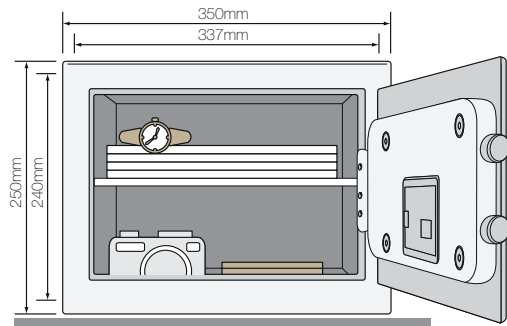

| | | | | |
|-------------|-----------|---|-------|------|
| | | | | |
| YSM/250/EG1 | Home safe | 1 | 16 kg | Grey |

Certified safes YSM/400/EG1 - Office safe

Specifications:

- 22mm electronically motorised locking bolts
- User code and mastercode function
- 6 lever double bitted manual override lock
- 2 keys supplied
- Laser cut door for minimum gap
- Reinforced hinge and mounted door opening spring
- Armoured steel anti drill plates: Side of safe, top of safe & between door and faceplate
- Volume 35.5 litres



Features:

- Digital keypad with blue backlight LCD display
- Resettable 3 to 8 digit usercode
- Low battery warning
- Display code on/off function
- Internal light

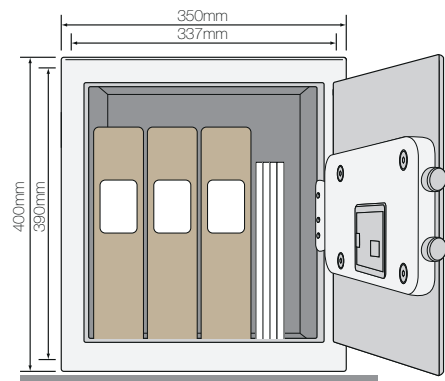

| | | | | |
|-------------|-------------|---|-------|------|
| | | | | |
| YSM/400/EG1 | Office safe | 1 | 23 kg | Grey |

Certified safes YSM/520/EG1 - Professional safe

Specifications:





- 22mm electronically motorised locking bolts
- User code and mastercode function
- 6 lever double bitted manual override lock
- 2 keys supplied
- Laser cut door for minimum gap
- Reinforced hinge and mounted door opening spring
- Armoured steel anti drill plates: Side of safe, top of safe & between door and faceplate
- Volume 49.8 litres

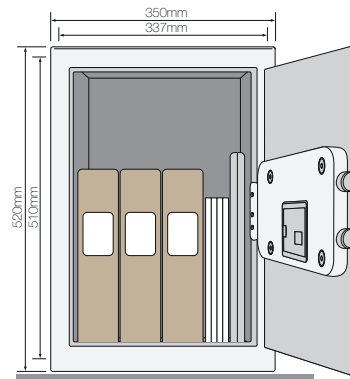

Features:

- Digital keypad with blue backlight LCD display
- Resettable 3 to 8 digit usercode
- Low battery warning
- Display code on/off function
- Internal light



| | | | | |
|---|---|---|---|---|
|  |  |  |  |  |
| YSM/520/EG1 | Professional safe | 1 | 29 | Grey |